

SAFEONE DN3PS2

Hardware

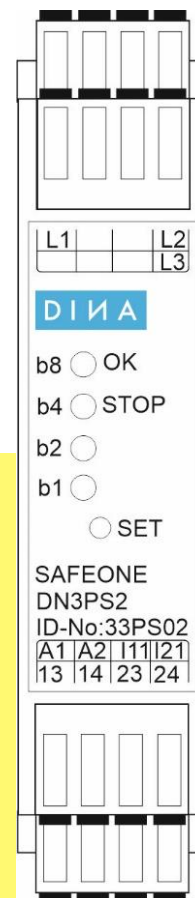

Safety switchgear to monitor the standstill of
three-phase and single-phase motors without sensor

DINA Elektronik GmbH

Esslinger Straße 84
72649 Wolfschlugen
Deutschland

Phone +49 7022 9517 0

Mail info@dina.de

Web www.dina.de

© Copyright by DINA Elektronik GmbH 2024

All parts of this documentation are protected by copyright.

Any use beyond that permitted under copyright law is not permitted without express written consent from the publisher. This applies in particular to the reproduction, distribution and translation of this documentation or parts thereof, as well as the storage and processing of this content using electronic data processing systems.

The information contained in this documentation corresponds to the technical state of the product at the time these operating instructions were published.

This manual is valid for:

Description	ID-No.
DN3PS2	33PS02
DN3PS2	33PS03
DN3PS2	33PS05
DN3PS2	33PS08

Legal information

Handbook: Hardware
Target group: Electricians, electrical designers
Editor: DINA Elektronik GmbH
File name: DN3PS2-Handbuch-en-202308.docx
Language: ENG
Publication as at: 20. March 2024

Table of content

1	Structure of the document	1
1.1	Conventions.....	1
1.1.1	Emphasizing information	1
1.1.2	Emphasizing paragraphs using typography.....	1
1.1.3	Emphasizing words using typography	1
1.2	Your opinion is important to us!.....	2
2	Safety	3
2.1	Warnings	3
2.1.1	Function of warnings	3
2.1.2	Design of warnings.....	3
2.1.3	Hazard symbols	4
2.2	Qualification of personnel	4
2.2.1	Electrician	4
2.2.2	Electrical designers.....	4
2.3	Intended use and improper use	5
2.3.1	Certification data	5
3	EC declaration of conformity	9
4	Product description	10
4.1	Function description.....	10
4.1.1	Connection 33PS02, 33PS03, 33PS05	11
4.1.2	Block diagram	12
4.1.3	Inputs I11 and I21	12
4.1.4	Example of application	13
4.1.5	Connection 33PS08	14
4.1.6	Block diagram	14
4.1.7	Signal outputs O1 und O2.....	15
4.2	Configuration	16
4.2.1	Setting the switching thresholds	16
4.2.2	Setting the switch-on delay	17
5.1	Motor with frequency converter.....	19
5.2	Motor with star-delta circuit	19
5.3	Single-phase motor.....	19

6	Diagnostics and switching status displays	20
6.1	LED indicators	20
6.2	Flash-codes	21
7	Order information	22
8	Technical data.....	22
8.1	Supply	22
8.2	Digital inputs	22
8.3	Measuring inputs	22
8.4	Signal outputs.....	22
8.5	Contact outputs	23
8.6	General data.....	23
8.7	Connection data	24
8.8	Environment conditions	24
8.9	Dimensions.....	24
8.10	Safety-related data	24
8.11	Safety-related parameters in accordance with DIN EN ISO 13849-1:2016-06	24
8.12	Contact life	25
9	Installation and removal.....	26
9.1	Installing a module.....	26
	9.1.1 Overview.....	26
9.2	Removing a module.....	26

1 Structure of the document

1.1 Conventions

Information of particular important is emphasized in this documentation through the use of symbols, typography or formulations.

1.1.1 Emphasizing information

The following symbols indicate important information:



Degree of hazard (e.g. WARNING): Triangular symbols indicate the degree of hazard in warnings.



Type of hazard (e.g. electrical shock – dangerous voltage): Triangular symbols indicate the type of hazard in warnings.



Information: Additional clarification.



Tip: Additional information to help optimize the workflow.

1.1.2 Emphasizing paragraphs using typography

The following typography is used to emphasize paragraphs with special functions:



Indicates an instruction.



Indicates an expected reaction.



Indicates an unexpected reaction.



Indicates an item in a list.

1.1.3 Emphasizing words using typography

The following typography is used to emphasize words with special functions:

(1)

Represents a numbered item in a figure.

→

Indicates a cross-reference to another page, figure or document.

1.2 Your opinion is important to us!

We do all we can to provide complete, accurate documentation for the product. If you have any suggestions for improvement or advice for us, please share your thoughts with us. Send us your comments by e-mail to the following address.

E-mail: info@dina.de

2 Safety

2.1 Warnings

2.1.1 Function of warnings

Warnings warn users about hazards when handling the product. The hazards are classified, specified, described and supplemented with information about how to avoid them.

- If there is a warning before a list of instructions, the hazard is present throughout the entire activity.
- If there is a warning immediately before an instruction, the hazard is present during the next step.

2.1.2 Design of warnings

All warnings are indicated by a signal word and a warning symbol. The different combinations of the signal word and warning symbol indicate the degree of danger.



DANGER

For an immediate hazard that will result in severe injuries or death.



WARNING

For an immediate hazard that could result in severe injuries or death.



CAUTION

For a potentially hazardous situation that could result in injuries.



CAUTION

For a potentially harmful situation in which the product or an item near it could be damaged.



CAUTION

For a hazard that could cause environmental damage.

2.1.3 Hazard symbols

**Note**

The warning symbol may be present alongside another hazard symbol that represents the type of hazard, in order to attract the reader's attention.

Hazard symbols are indicated by a triangular symbol in the context of warnings. The following hazard symbols are used in this documentation:



Electric shock – dangerous voltage!

2.2 Qualification of personnel

DINA Elektronik GmbH distinguishes between specialist staff with different qualifications when it comes to carrying out work on the product. The minimum required qualifications are specified for each task and are defined as follows:

2.2.1 Electrician

Specialist who installs, maintains and repairs the electrical system in the product. A specialist is a person whose specialist training means that they have the knowledge and experience, including knowledge of relevant regulations, necessary to assess the work assigned to them and the potential hazards.

**Note**

When evaluating a person's specialist training, multiple years of work in the relevant field may also be taken into account.

→ **DIN VDE 1000-10** Requirements for persons working in a field of electrical engineering.

2.2.2 Electrical designers

Specialists who design the electrical system and the product. A specialist is a person whose specialist training means that they have the knowledge and experience, including knowledge of relevant regulations, necessary to assess the work assigned to them and the potential hazards.

**Note**

When evaluating a person's specialist training, multiple years of work in the relevant field may also be taken into account.

→ **DIN VDE 1000-10** Requirements for persons working in a field of electrical engineering.

2.3 Intended use and improper use

The product has exclusively been developed for use for the purpose described here. The specifications set out in these operating instructions must be strictly complied with.

- **DN3PS2** is a safety switchgear to monitor the speed of three-phase and single-phase motors without sensor.
- The safety module is intended for use on machines and plants to prevent hazards from arising.

Any other form of use is regarded as improper use.

If the product is

- not used as intended,
- improperly maintained or
- incorrectly operated,

the manufacturer will not assume any liability for any damage that results. In this case, the risk shall be borne exclusively by the user.

2.3.1 Certification data

The product is certified as safety equipment in accordance with:

<ul style="list-style-type: none"> ▪ DIN EN ISO 13849-1:2015 Category 4, PLe 	
<ul style="list-style-type: none"> ▪ EC type examination certificate 	Notified body: TÜV Rheinland Industrie Service GmbH Am Grauen Stein 51105 Köln Germany NB 0035
<ul style="list-style-type: none"> ▪ EMC Directive 	Certified by: ELMAC GmbH Bondorf
<ul style="list-style-type: none"> ▪ CNL, USL 	File E227037
<ul style="list-style-type: none"> ▪ QA system certified as per DIN EN ISO 9001:2015 	Certified by: DQS GmbH, 60433 Frankfurt am Main, Germany



Note

You can download the certificates from our website:

→ <https://www.dina.de/downloads>

2.4 Documentation

Operating instructions contain instructions on how to use a product safely, correctly and cost-effectively. Follow the instructions in these operating instructions in order to prevent hazards, avoid repair costs and standstill, and improve the reliability and service life of the product. You must read the operating instructions and ensure that you understand them.



- ▶ Before working with the product, read the documentation
 - ▶ Always ensure that the operating instructions are available where the product is in use.
-

2.5 Safety regulations

The safety regulations listed below must always be complied with. In the event that these safety regulations are not complied with or the device is used improperly, **DINA Elektronik GmbH** accepts no liability for any resulting injury or damage.

- The product must only be installed and commissioned by a skilled electrician or a trained, instructed person, who is familiar with these operating instructions and the applicable specifications regarding occupational health and safety and accident prevention.
-



WARNING

Danger to persons and materials! In the event that specifications are not complied with, this can result in death, severe injuries or significant material damage.

Observe VDE, EN and local regulations, in particular with regard to protective measures.

- If the emergency stop is used, either the integrated restart prevention function must be used or the machine must be prevented from restarting automatically using a superordinate control system.
 - When installing the device, the required distances as per DIN EN 50274, VDE 0660514 must be taken into account.
 - ▶ During transport, storage and operation, comply with the conditions set out in EN 60068-2-1, 2-2.
 - ▶ Assemble the device in a control cabinet with at least IP54 degree of protection. Otherwise, dust and moisture can impair the functions. The device must be installed in a control cabinet.
 - ▶ Ensure that the output contacts have sufficient protective circuitry for capacitive and inductive loads.
 - ▶ Follow the specifications in the general technical data.
-

**Note**

More detailed information can be found in the → **Technical data** section.

**WARNING**

Electric shock – dangerous voltage! During operation, switching devices conduct dangerous voltages.

Never remove protective covers from electrical switching devices during operation.

- ▶ Replace the device the first time a fault occurs.
-



- ▶ Dispose of the device in accordance with nationally applicable environmental regulations.
-

2.5.1 Retrofitting and conversion

- Unauthorized conversion voids any warranty. This can cause hazards that can lead to severe or even fatal injury.

2.5.2 Basic safety regulations

The safety regulations listed below must always be complied with. In the event that these safety regulations are not complied with or the device is used improperly, **DINA Elektronik GmbH** accepts no liability for any resulting injury or damage.

- The product described here has been developed to perform safety-related functions as part of an entire system.
- The entire system is made up of sensors, analysis units, reporting units and safe switch-off concepts.
- It is the responsibility of the manufacturer of a system or machine to validate the correct overall function.
- The manufacturer of the system is obligated to check and document the efficacy of the implemented safety concept within the entire system. This documentation must be produced again every time the safety concept or safety parameters are modified.
- The manufacturer's specifications for the system or machine with regard to maintenance intervals must be complied with.
- **DINA Elektronik GmbH** is not able to make any guarantees regarding the properties of an overall system not designed by the company.
- **DINA Elektronik GmbH** accepts no liability for any recommendations given or implied in the following description.
- No new guarantee, warranty or liability claims that go beyond **DINA Elektronik GmbH's** general delivery conditions can be derived from the following description.

- To prevent EMC disturbances, the physical environmental and operating conditions where the product is installed must correspond to the EMC section of DIN EN 602041.
- If contact outputs are used, the safety function must be requested at least once per month for Performance Level (e) and once per year for Performance Level (d).

2.6 Working on live parts



WARNING



Electric shock – dangerous voltage! Touching live components can cause severe or even fatal injury, depending on circumstances, as a result of an electric shock.

- ▶ Never assume that a circuit is dead.
 - ▶ Always check circuits as a safety precaution! Components being worked on may only be live if this is absolutely necessary and stipulated.
 - ▶ Accident prevention regulations (e.g. VBG4 and VDE 105) must be observed during all work.
 - ▶ Only use suitable, intact tools and measuring equipment.
-

3 EC declaration of conformity



Original EG-Konformitätserklärung

(gemäß der Richtlinie 2006/42/EG, Anhang II, IA)

Original EC-Declaration of Conformity

(according to Directive 2006/42 / EC, Annex II, IA)

DINA Elektronik GmbH
 Esslinger Str. 84
 72649 Wolfschlugen
 Deutschland

Wir erklären, dass folgendes Produkt allen einschlägigen Bestimmungen der Richtlinie 2006/42/EG entspricht.
 We declare, that the following product fulfills all the relevant provisions of Directive 2006/42 / EC.

Produkt/Product	Funktion/Function
DN3PS2 Sicherheitsrelais-Modul zur Stillstandsüberwachung/ Safety module for standstill monitoring ID-No. 33PS_	Sensorlose Stillstandsüberwachung bei Ein- und Dreiphasen-Motoren Sensorless standstill monitoring for single phase and 3-phases motors

Weitere EU-Richtlinien/Further EC- directives
2014/30/EU EMV-Richtlinie/EMC-Directive 2011/65/EU RoHS Richtlinie/RoHS-Directive

Benannte Stelle/Notified Body	EG Baumusterprüfbescheinigung/EC Type-Examination certificate
TÜV Rheinland Industrie Service GmbH Am Grauen Stein 51105 Köln Germany NB 0035	Reg.-Nr./No.: 01/205/5028.02/20

Bevollmächtigter für die Zusammenstellung der technischen Unterlagen/ Authorized representative for the compilation of the technical documents
DINA Elektronik GmbH Esslinger Str. 84 72649 Wolfschlugen Deutschland



Stefan Najib
 Geschäftsführer/CEO

Wolfschlugen, 06.04.2021

4 Product description

The **SAFEONE DN3PS2** is a safety switchgear for sensorless standstill monitoring of electric drives.

- In the event of drive movement or errors, the potential-free NO output contacts switch to the rest position.
- The restart can be parameterized with a time delay.
- The readiness for operation and the switching status of the contact outputs are displayed via LEDs.
- The device is intended for mounting on a 35mm standard rail.

4.1 Function description

Standstill is detected by evaluating the induced voltage (EMF) when the motor is coasting.

- After applying the operating voltage (24 V DC) to terminals A1 and A2, the safety relay will operate a self-test. The safety relay is in safe condition for the duration of the self-test. The LED OK lights up red.
- The device is ready for operation, when the LED OK lights up green.
- If the voltage measured at the measuring inputs is lower than the switching threshold S1 set on the device, the enabling current path switches on with a time delay. The STOP LED lights up green.
- The enabling current path opens immediately when the measured voltage exceeds the set switching threshold S2. The STOP LED goes out.



CAUTION

Note that the method of frequency measurement does not recognize a mechanically blocked motor.



WARNING

The wire break error is automatically acknowledged as soon as the error is no longer present.

- ▶ Ensure suitable protective measures to prevent an automatic restart.
-

The DN3PS2 is available in different variants

ID-No.	Variant
33PS02	Standard
33PS03	Higher sensitivity, longer switch-on delay times
33PS05	Single-channel muting of relay contact 13/14
33PS08	2 signal outputs, no muting inputs

4.1.1 Connection 33PS02, 33PS03, 33PS05

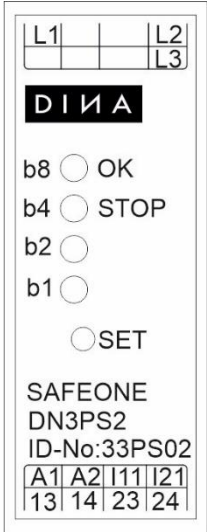
 <p> L1 L2 L3 DI A b8 <input type="radio"/> OK b4 <input type="radio"/> STOP b2 <input type="radio"/> b1 <input type="radio"/> <input type="radio"/> SET SAFEONE DN3PS2 ID-No:33PS02 A1 A2 I11 I21 13 14 23 24 </p>	A1	Power supply +24V DC
	A2	Power supply 0 V
	L1, L2, L3	Measuring inputs are to be connected directly to the motor
	I11	Digital input for muting-function
	I21	Digital input for muting-function
	13/14, 23/24	Enabling contacts
	LED OK	operational readiness
	LED STOP	state of the enabling current path
	LED b1, b2, b4, b8	Binary-coded display of the set parameters

4.1.2 Block diagram

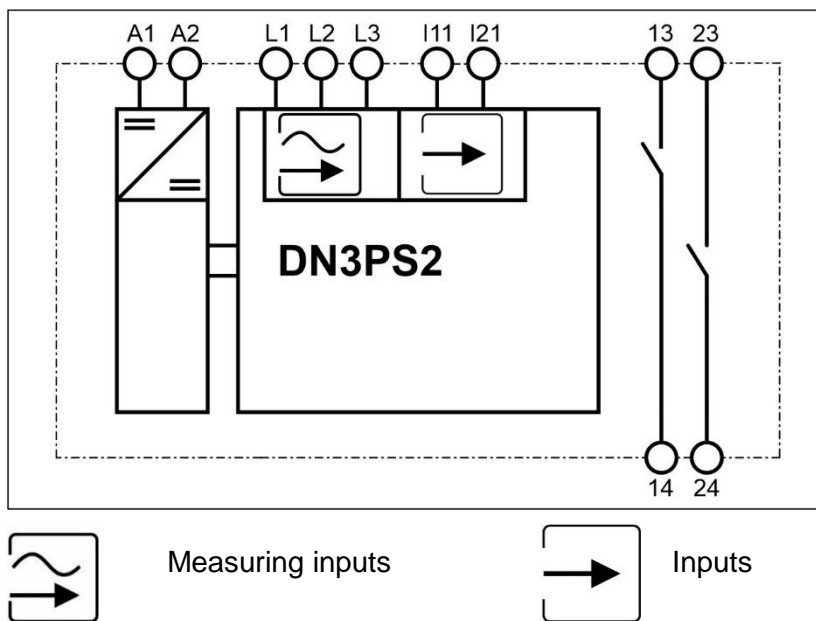

4.1.3 Inputs I11 and I21

With the variants 33PS02, 33PS03, 33PS05, two different types of function are possible. The function type is selected via inputs I11 and I21.

Function type 1	Function type 2 (Muting)
<ul style="list-style-type: none"> ▶ I11 und I21 not connected ◀ Standstill monitoring is constantly active. ◀ Enable contacts close when the drive is at standstill. 	<ul style="list-style-type: none"> ▶ I11 und I21 connected ◀ Standstill monitoring is not active. ◀ Enable contacts are closed ¹⁾ ◀ The "wire break" and "single-channel" error detection is inactive. ²⁾

¹⁾ with 33PS05 only the release contact 13/14 remains closed. The release contact 23/24 switches off when there is movement.

²⁾ not with 33PS05

4.1.4 Example of application

When the protective device is open, inputs I11 and I21 are not connected. Standstill monitoring is active and the enabling current path only closes when the drive is at standstill.

When the protective device is closed, standstill monitoring is **not** active and the enabling current path is closed

24 V DC

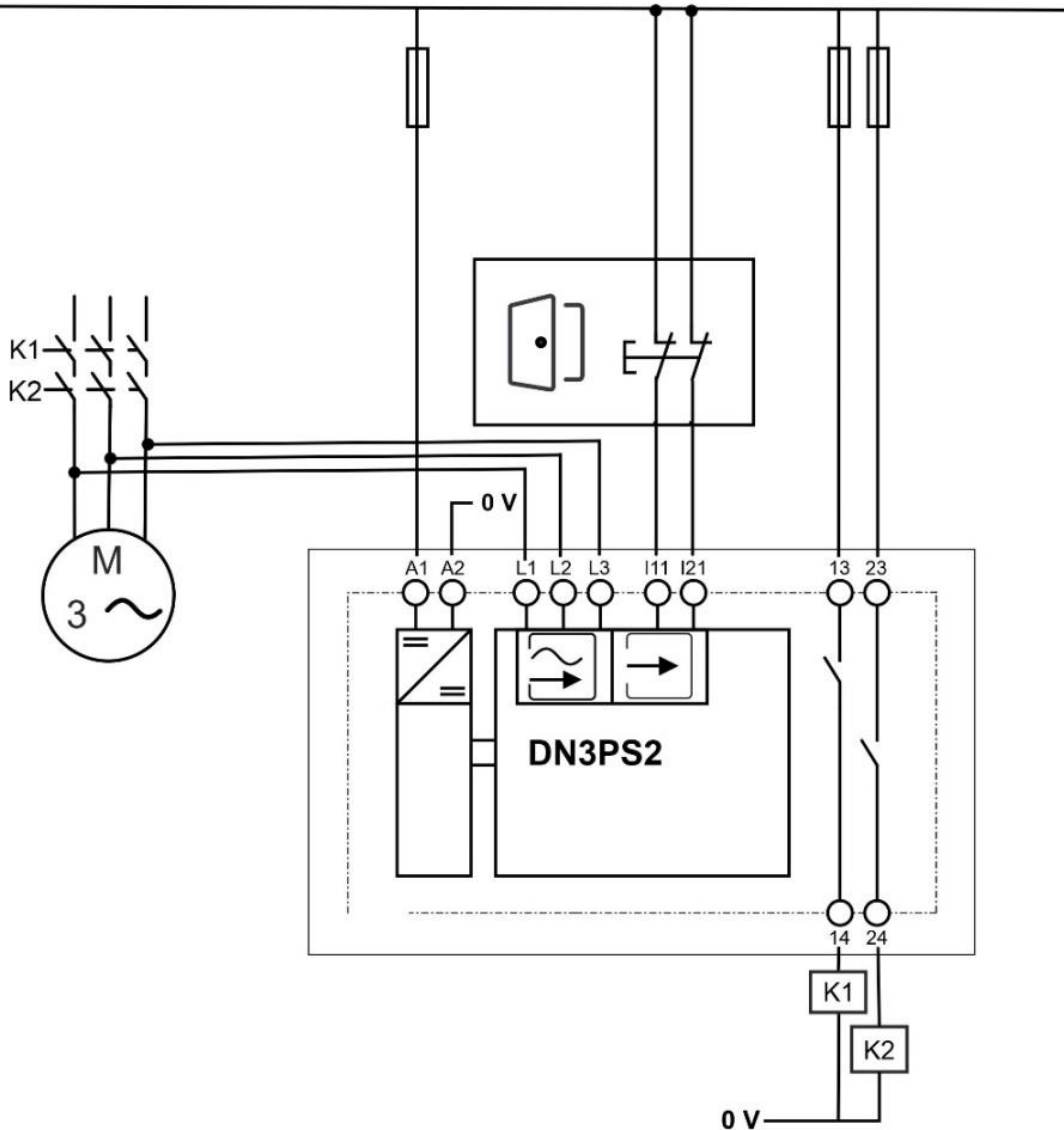

4.1.5 Connection 33PS08

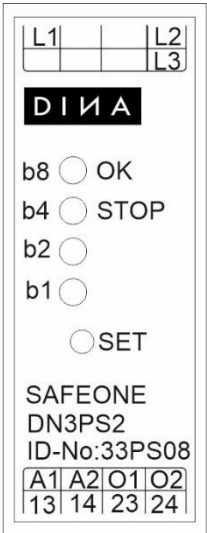
	A1	Power supply +24V DC
	A2	Power supply 0 V
	L1, L2, L3	Measuring inputs are to be connected directly to the motor
	O1	Signal output
	O2	Signal output
	13/14, 23/24	Enabling contacts
	LED OK	operational readiness
	LED STOP	state of the enabling current path
	LED b1, b2, b4, b8	Binary-coded display of the set parameters

4.1.6 Block diagram

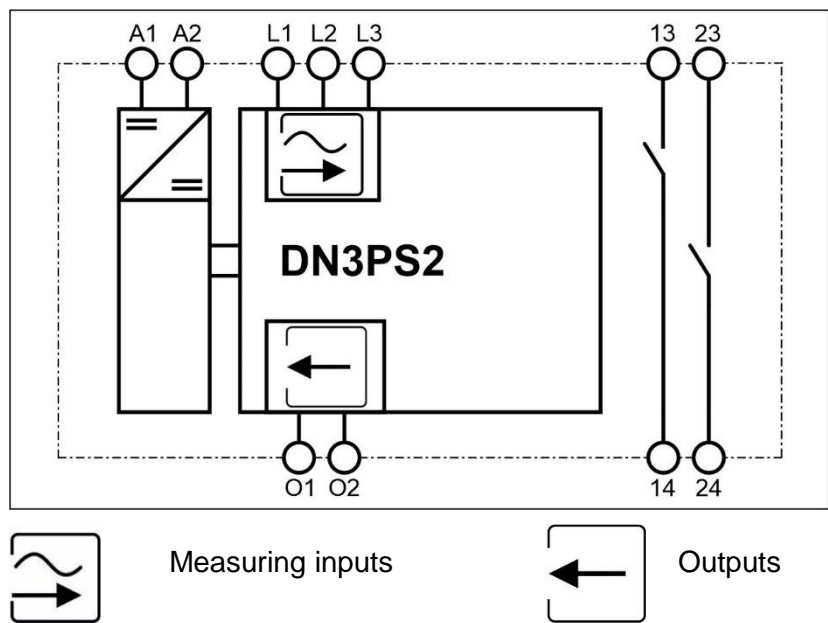

4.1.7 Signal outputs O1 und O2

The signal outputs O1 and O2 indicate the operating and device status.

O1	O2	Status
24V	24V	Standstill
0V	24V	Motion
0V	0V	Error

The signal outputs have the following properties:

- digital
- potential-bound
- short circuit and overload protection
- not safety-related

4.2 Configuration

The switching thresholds and the switch-on delay are set using the SET button on the front. The two-color LEDs b1, b2, b4, b8 show the current status in binary code.

- During the setting mode, the safety function and error monitoring are active.
- If the operating voltage is interrupted during the setting mode or if no button is pressed for ≥ 20 s, the setting is ended without being saved. The previous parameter values remain effective.
- The parameterization is not possible if an error (e.g. wire break) is present.



WARNING

The correct setting of the parameters is a prerequisite for safe operation and is the responsibility of the user.



A VDE-insulated screwdriver according to EN60900 must be used to press the SET button.

4.2.1 Setting the switching thresholds

- ▶ Hold down the SET button for 3s until all LEDs flash red.
- ◀ The LEDs flash according to the currently set switching threshold.
- ▶ You can change the switching threshold by briefly pressing the SET button.
- ◀ The LEDs show you the setting according to Table 4 1.
- ▶ Keep the SET button pressed for 2s.
- ◀ The set value is saved and the setting mode is exited.

Legend



LED on



LED off

S1 switching thresholds 1, Enabling contacts closed

1) switching thresholds 1 at 33PS03, Enabling contacts closed

S2 switching thresholds 2, Enabling contacts open

2) Default setting when delivered





























































b8															
b4															
b2															
b1															
S1 (mV)	50	55	60	65	70	75	80 ²⁾	200	230	250	300	350	400	460	500
S1 ¹⁾ (mV)	12	18	24	30	36	48	61 ²⁾	200	230	250	300	350	400	460	500
S2 (mV)	120	120	120	120	120	120	120	1000	1000	1000	1000	1000	1000	1000	1000

Table 4-1

**WARNING**

In the case of applications with servo motors, the switching thresholds may only be set in the range from 1 to 7. With settings 8 to 15, the engine standstill may be detected too early.

4.2.2 Setting the switch-on delay

- ◀ Hold down the SET button for 6s until all LEDs flash green.
- ◀ The LEDs flash according to the currently set switch-on delay.
- ▶ You can change the switch-on delay by briefly pressing the SET button.
- ◀ The LEDs show you the setting according to Table *Table 4-2*.
- ▶ Keep the SET button pressed for 2s.
- ◀ The set value is saved and the setting mode is exited.

Legend



LED on



LED off

t switch-on delay

1) switch-on delay at 33PS03

2) Default setting when delivered

3) 0 s at 33PS08-01

b8															
b4															
b2															
b1															
t (s)	0,5	1 ²⁾	2	3	4	5	6	7	8	10	12	14	16	18	20
t (s) 1)	0,5 3)	1 ²⁾	2	3	4	5	6	7	8	10	12	15	20	30	40

Table 4-2

5 Applications

5.1 Motor with frequency converter

The operation on electric power drive systems with adjustable speed is possible.

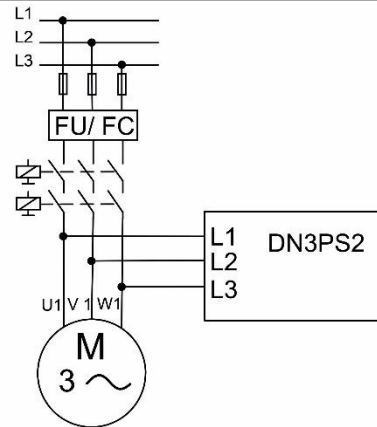

5.2 Motor with star-delta circuit

Operation on motors with star-delta connection or pole changeover is possible.

- ▶ Make sure that the measuring inputs L1, L2, L3 are always connected directly to the motor connections.

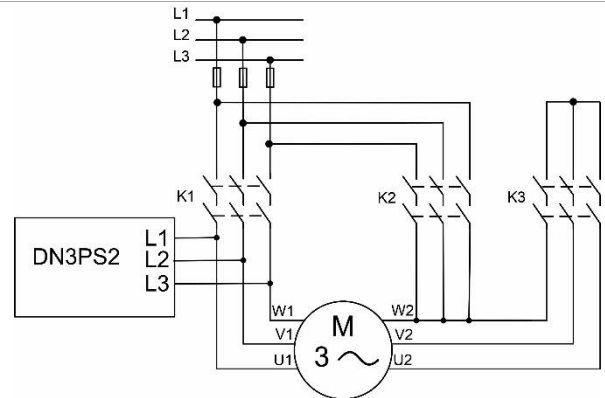

5.3 Single-phase motor

Operation on a single-phase motor is possible.

- ▶ Bridge the measuring inputs L1 und L3 and connect them directly to the motor connection U1.
- ▶ Connect the measuring input L2 directly to the motor connection U2.

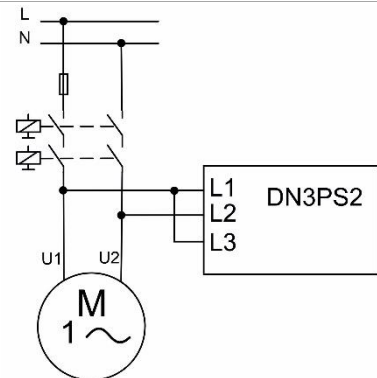

6 Diagnostics and switching status displays

The modules have a display for

- Ready to use
- Status of the release contacts
- Display of the set parameters

6.1 LED indicators

Legend



LED on



LED off



LED flashing

LED	State	Status
OK		Power off
		Self-test
		Ready to use
		Error see chapter. „Flash-codes“
STOP		enabling current path open
		enabling current path closed
		Switch-on delay time t expires
b1 to b8		Setting the switching threshold
		Setting the switch-on delay time

6.2 Flash-codes

The safety switching device uses a flashing code of the "OK" LED to indicate errors, which lead to the safe state of the device.

The blink code repeats continuously with a pause of 1 s.

The meaning of the individual blink codes can be found in the table.

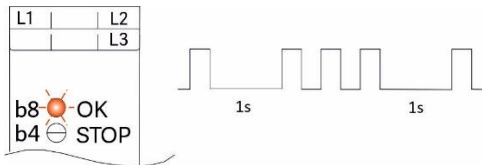

Flash-Code	Definition	Remedy
1 x flash	Internal error	▶ Send the device to DINA Elektronik for testing.
2 x flash	incorrect power supply	▶ Check power supply UB = 20.5V-26,5V DC
3 x flash	Open-circuit on L1, L2, L3	▶ Check the wiring at the measuring inputs for <ul style="list-style-type: none"> ▪ wire break ▪ presence of direct voltage
4 x flash	single-channel error The signals at the measuring inputs are different.	▶ Check the wiring at the measuring inputs for <ul style="list-style-type: none"> ▪ short circuit ▪ cross-connection ▪ wire break
5 x flash	Relay error	▶ Send the device to DINA Elektronik for testing.
8 x flash	Unequal wiring of inputs I11 / I21	▶ Check the wiring of the inputs I11/21.



Note

In the function type 2 (Muting) are the error "wire break" and "single-channel" inactive.

7 Order information

Description	Product	ID-No.
Standstill monitoring without sensor	SAFEONE	33PS02
	DN3PS2	33PS03
		33PS05
		33PS08

8 Technical data

8.1 Supply

Operating voltage UB	24 V DC (-15/+10%)
Current consumption at 24V	< 80 mA
Power consumption at A1/A2	2,8 W

8.2 Digital inputs

Inputs	I11, I21
Input voltage range	24 V DC (-15/+10%)
Current consumption	typ. 4 mA (at UB)

8.3 Measuring inputs

Inputs	L1, L2, L3
Input voltage range	90V to 690V AC
Current consumption	0,35mA at 690V AC/5kHz

8.4 Signal outputs

Outputs	O1, O2
Output type	
Voltage	UB-1V

Switching current	≤ 100mA, short-circuit and overload-proof (only with ID-No. 33PS08)
-------------------	--

8.5 Contact outputs

Outputs	13/14, 23/24
Contact material	AgNi
Output guidance, performance level	
Minimum switching current	10 mA
Maximum switching current	8 A
Switching capacity in accordance with IEC 60947-5-1	DC13: 3A/24V AC15: 3A/230V
Mechanical service life	>20 x10 ⁶ Switching cycles
Maximum switching cycles	20 Switching cycles/s
Contact fuse	5 A gL/gG
Typical response time	10 ms / 5 ms

8.6 General data

Type of protection (housing and terminals)	IP 20
Type of protection (place of installation)	min. IP 54
Clearance and creepage distances between circuits	According to DIN EN 50178
Rated insulation voltage	250 V AC
Rated surge voltage/insulation	4 kV
Degree of contamination	2
Overvoltage category	III
Housing material	Polyamide PA not reinforced
Weight	130g

8.7 Connection data

Terminals	Push-in, pluggable
Conductor cross section	0,25 – 2,5mm ²
AWG conductor cross section	24...12
Conductor type	Flexible with end sleeves
Stripping length	8 mm

8.8 Environment conditions

Operating temperature	-20 °C to +55 °C
Storage temperature	-40 °C to +85 °C
Attitude of place of use	< 2000m above sea level
Shock	10g

8.9 Dimensions

B x H x T	22,5 x 114 x 111 mm (0.886 x 4.488 x 4.370 in)
Size of DIN rail	35,0 mm (1.378 in)

8.10 Safety-related data

Stop category in accordance with IEC 60204	0
--	---

8.11 Safety-related parameters in accordance with DIN EN ISO 13849-1:2016-06

Performance Level	e
Category	4
MTTFd [a]	77
PFHd	4E-08

8.12 Contact life

Electrical service life of the output contacts in accordance with DIN EN 60947-5-1/ Annex C.3

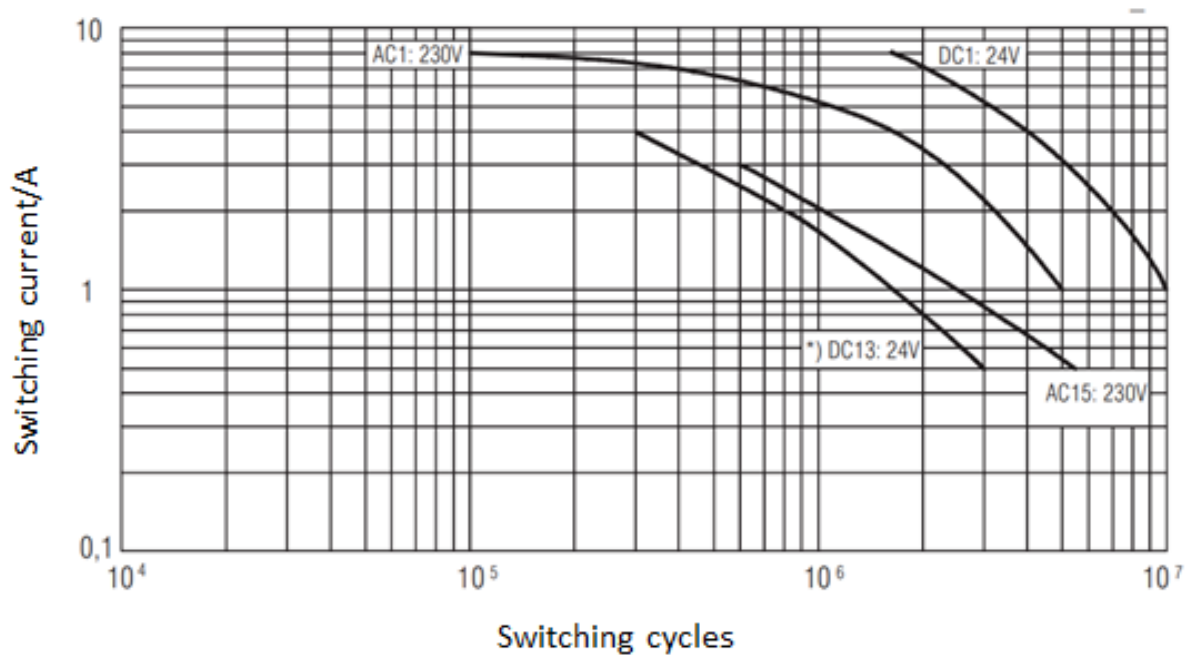

9 Installation and removal

9.1 Installing a module

9.1.1 Overview

(A) 70-75 mm (2,756-2,953 in)

- (1) Top hat rail
- (2) Locking slider
- (3) Cable duct

Procedure

- ▶ Hook the module onto the top hat rail (1) and press it downward.
- ◀ The locking slider (2) engages under the top hat rail.

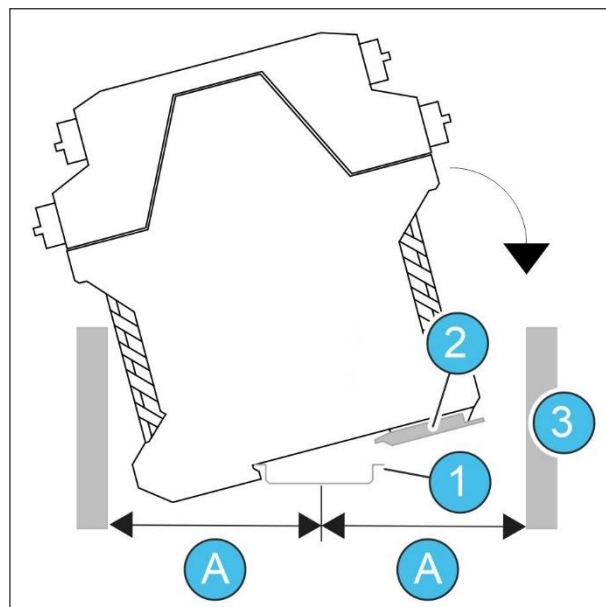

9.2 Removing a module

Procedure

- ▶ Use a screwdriver (1) to move the locking slider away from the module.
- ▶ Move the module upward and remove it from the rail.

