

# SAFEONE DNSR-2R2 Time Delay Relay

## Hardware

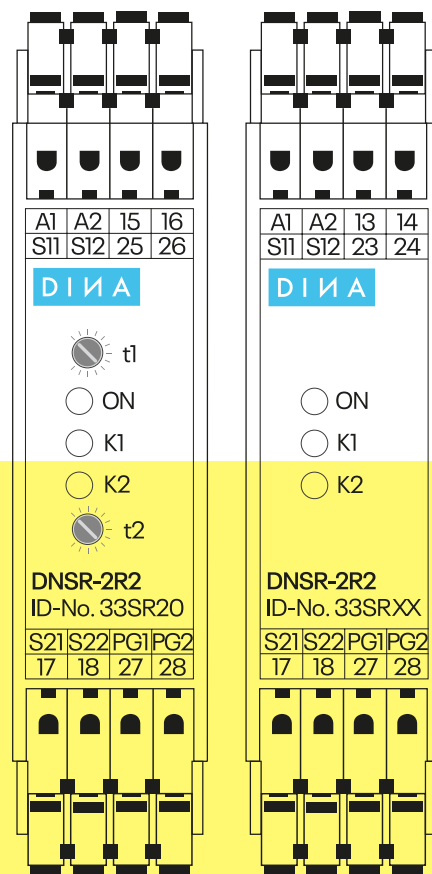

Switching device for enabling and time delayed enabling of control circuits

## **DINA Elektronik GmbH**

Esslinger Straße 84  
72649 Wolfschlugen  
Germany

**Phone** +49 7022 9517 0

**Fax** +49 7022 9517 700

**Mail** info@dina.de

**Web** www.dina.de

© Copyright by DINA Elektronik GmbH 2021

All parts of this documentation are protected by copyright.

Any use beyond that permitted under copyright law is not permitted without express written consent from the publisher. This applies in particular to the reproduction, distribution and translation of this documentation or parts thereof, as well as the storage and processing of this content using electronic data processing systems.

The information contained in this documentation corresponds to the technical state of the product at the time these operating instructions were published.

This documentation applies to:

<b>Designation</b>	<b>ID no.</b>
DNSR-2R2	33SR15-18
DNSR-2R2	33SR20

### **Legal information**

Handbook:	Hardware
Target group:	Electricians, electrical designers
Editor:	DINA Elektronik GmbH
File name:	BA_DNSR-2R2_zeitrelais-d-V01
Language:	EN
Publication as at:	July 9, 2021

# Table of Contents

<b>1</b>	<b>Structure of the document</b>	<b>5</b>
1.1	Conventions	5
1.1.1	Emphasizing information	5
1.1.2	Emphasizing paragraphs using typography	5
<b>2</b>	<b>Safety</b>	<b>7</b>
2.1	Warnings	7
2.1.1	Function of warnings	7
2.1.2	Design of warnings	7
2.1.3	Hazard symbols	8
2.2	Qualification of personnel	8
2.2.1	Electrician	8
2.2.2	Electrical designers	8
2.3	Intended use and improper use	9
2.3.1	Certification data	9
2.4	Documentation	10
2.5	Safety regulations	10
2.5.1	Retrofitting and conversion	11
2.5.2	Basic safety regulations	11
2.6	Working on live parts	12
<b>3</b>	<b>EC declaration of conformity</b>	
<b>4</b>	<b>Product description</b>	<b>14</b>
4.1	Pin assignment 33SR15 to 33SR18	14
4.2	Functional specification for 33SR15 to 33SR18	15
4.2.1	Application example for control input PGI	15
4.3	Pin assignment 33SR20	16
4.4	Functional specification for 33SR20	16
4.5	Setting the delay times	17
<b>5</b>	<b>Diagnostics and switching status displays</b>	<b>18</b>
5.1	LED indicators	18
<b>6</b>	<b>Order information</b>	<b>19</b>

<b>7</b>	<b>Technical data</b>	<b>19</b>
7.1	Supply	19
7.2	Digital inputs	19
7.3	Voltage outputs	19
7.4	Contact outputs	20
7.5	General data	20
7.6	Connection data	21
7.7	Environmental conditions	21
7.8	Dimensions	21
7.9	Safety technical data	21
7.10	Safety-related parameters in accordance with DIN EN ISO 13849-1:2016-06	22
7.11	Contact life	22
<b>8</b>	<b>Installation and removal</b>	<b>23</b>
8.1	Installing a module	23
8.1.1	Overview	23
8.2	Removing a module	23

# 1 Structure of the document

## 1.1 Conventions

Information of particular important is emphasized in this documentation through the use of symbols, typography or formulations.

### 1.1.1 Emphasizing information

The following symbols indicate important information:



Degree of hazard (e. g. **WARNING**):  
Triangular symbols indicate the degree of hazard in warnings.



Type of hazard (e.g. **electrical shock – dangerous voltage**):  
Triangular symbols indicate the type of hazard in warnings.



**Information:** Additional clarification



**Tip:** Additional information to help optimize the workflow.

### 1.1.2 Emphasizing paragraphs using typography

The following typography is used to emphasize paragraphs with special functions:



Indicates an instruction.



Indicates an expected reaction.



Indicates an unexpected reaction.



Indicates an item in a list.

### 1.1.3 Emphasizing words using typography

The following typography is used to emphasize words with special functions:



Represents a numbered item in a figure.



Indicates a cross-reference to another page, figure or document.

## 1.2 We value your opinion!

We do all we can to provide complete, accurate documentation for the product. If you have any suggestions for improvement or advice for us, please share your thoughts with us. Send us your comments by e-mail to the following address.

**E-Mail: [info@dina.de](mailto:info@dina.de)**

# 2 Safety

## 2.1 Warnings

### 2.1.1 Function of warnings

Warnings warn users about hazards when handling the product. The hazards are classified, specified, described and supplemented with information about how to avoid them.

- If there is a warning before a list of instructions, the hazard is present throughout the entire activity.
- If there is a warning immediately before an instruction, the hazard is present during the next step.

### 2.1.2 Design of warnings

All warnings are indicated by a signal word and a warning symbol. The different combinations of the signal word and warning symbol indicate the degree of danger.

**DANGER**

For an immediate hazard that will result in severe injuries or death.

**WARNING**

For an immediate hazard that could result in severe injuries or death.

**CAUTION**

For a potentially hazardous situation that could result in injuries.

**CAUTION**

For a potentially harmful situation in which the product or an item near it could be damaged.

**CAUTION**

For a hazard that could cause environmental damage.

### 2.1.3 Hazard symbols



#### Note

The warning symbol may be present alongside another hazard symbol that represents the type of hazard, in order to attract the reader's attention.

Hazard symbols are indicated by a triangular symbol in the context of warnings. The following hazard symbols are used in this documentation:



**Electric shock – dangerous voltage!**

## 2.2 Qualification of personnel

**DINA Elektronik GmbH** distinguishes between specialist staff with different qualifications when it comes to carrying out work on the product. The minimum required qualifications are specified for each task and are defined as follows:

### 2.2.1 Electrician

Specialist who installs, maintains and repairs the electrical system in the product. A specialist is a person whose specialist training means that they have the knowledge and experience, including knowledge of relevant regulations, necessary to assess the work assigned to them and the potential hazards.



#### Note

When evaluating a person's specialist training, multiple years of work in the relevant field may also be taken into account.

→ **DIN VDE 1000-10** Requirements for persons working in a field of electrical engineering

### 2.2.2 Electrical designers

Specialists who design the electrical system and the product. A specialist is a person whose specialist training means that they have the knowledge and experience, including knowledge of relevant regulations, necessary to assess the work assigned to them and the potential hazards.



#### Note

When evaluating a person's specialist training, multiple years of work in the relevant field may also be taken into account.

→ **DIN VDE 1000-10** Requirements for persons working in a field of electrical engineering



## 2.3 Intended use and improper use

The product has exclusively been developed for use for the purpose described here. The specifications set out in these operating instructions must be strictly complied with.

- The DNSR-2R2 is a switching device for enabling and time delayed enabling of control circuits.
- The safety module is intended for use on machines and plants to prevent hazards from arising.

Any other form of use is regarded as improper use.

If the product is

- not used as intended,
- improperly maintained or
- incorrectly operated,

the manufacturer will not assume any liability for any damage that results. In this case, the risk shall be borne exclusively by the user.

### 2.3.1 Certification data

The product is certified as safety equipment in accordance with:

<ul style="list-style-type: none"> <li>• DIN EN ISO 13849-1:2016-06, Category 3, PLd</li> </ul>	
<ul style="list-style-type: none"> <li>• DGUV Test: GS-ET-20:2016-10</li> <li>• EC type examination certificate</li> </ul>	Notified body: <b>DGUV Test</b> Prüf- and Zertifizierungsstelle Elektrotechnik, Fachbereich: ETEM Gustav-Heinemann-Ufer 130 50968 Cologne, Germany (Reg. no.: 0340)
<ul style="list-style-type: none"> <li>• EMC Directive</li> </ul>	Certified by: <b>ELMAC GmbH Bondorf</b>
<ul style="list-style-type: none"> <li>• CNL, USL</li> </ul>	File E227037
<ul style="list-style-type: none"> <li>• QM system certified as per DIN EN ISO 9001:2015</li> </ul>	Certified by: <b>DQS GmbH</b> 60433 Frankfurt am Main, Germany



#### NOTE

You can download the certificates from our website:

→ <https://www.dina.de/downloads>

## 2.4 Documentation

Operating instructions contain instructions on how to use a product safely, correctly and cost-effectively. Follow the instructions in these operating instructions in order to prevent hazards, avoid repair costs and standstill, and improve the reliability and service life of the product. You must read the operating instructions and ensure that you understand them.



- ▶ Before working with the product, read the operating instructions that come with the product.
- ▶ Always ensure that the operating instructions are available where the product is in use.

## 2.5 Safety regulations

The safety regulations listed below must always be complied with. In the event that these safety regulations are not complied with or the device is used improperly, **DINA Elektronik GmbH** accepts no liability for any resulting injury or damage.

- The product must only be installed and commissioned by a skilled electrician or a trained, instructed person, who is familiar with these operating instructions and the applicable specifications regarding occupational health and safety and accident prevention.

### WARNING



**Danger to persons and materials!** In the event that specifications are not complied with, this can result in death, severe injuries or significant material damage.

- ▶ Observe VDE, EN and local regulations, in particular with regard to protective measures.
- If the emergency stop is used, either the integrated restart prevention function must be used or the machine must be prevented from restarting automatically using a superordinate control system.
- When installing the device, the required distances as per DIN EN 50274, VDE 0660514 must be taken into account.
- ▶ During transport, storage and operation, comply with the conditions set out in EN 60068-2-1, 2-2.
- ▶ Assemble the device in a control cabinet with at least IP54 degree of protection. Otherwise, dust and moisture can impair the functions. The device must be installed in a control cabinet.
- ▶ Ensure that the output contacts have sufficient protective circuitry for capacitive and inductive loads.
- ▶ Follow the specifications in the general technical data.



**Note**

More detailed information can be found in the **R Technical data** section.



**WARNING**

**Electric shock – dangerous voltage!** During operation, switching devices conduct dangerous voltages.



Never remove protective covers from electrical switching devices during operation.

► **Replace the device the first time a fault occurs.**



Dispose of the device in accordance with nationally applicable environmental regulations.

## 2.5.1 Retrofitting and conversion

- Unauthorized conversion voids any warranty. This can cause hazards that can lead to severe or even fatal injury.

## 2.5.2 Basic safety regulations

The safety regulations listed below must always be complied with. In the event that these safety regulations are not complied with or the device is used improperly, **DINA Elektronik GmbH** accepts no liability for any resulting injury or damage.

- **The product described here has been developed to perform safety-related functions as part of an entire system.**
- **The entire system is made up of sensors, analysis units, reporting units and safe switch-off concepts.**
- **It is the manufacturer's responsibility to ensure that a system or machine is functioning correctly as a whole.**
- **The manufacturer of the system is obligated to check and document the efficacy of the implemented safety concept within the entire system. This documentation must be produced again every time the safety concept or safety parameters are modified.**
- **The manufacturer's specifications for the system or machine with regard to maintenance intervals must be complied with.**

- **DINA Elektronik GmbH** is not able to make any guarantees regarding the properties of an overall system not designed by the company.
- **DINA Elektronik GmbH** accepts no liability for any recommendations given or implied in the following description.
- No new guarantee, warranty or liability claims that go beyond **DINA Elektronik GmbH's** general delivery conditions can be derived from the following description.
- To prevent EMC disturbances, the physical environmental and operating conditions where the product is installed must correspond to the EMC section of DIN EN 60204-1.
- If contact outputs are used, the safety function must be requested at least once per month for Performance Level (e) and once per year for Performance Level (d).

## 2.6 Working on live parts

### WARNING

**Electric shock – dangerous voltage!** Touching live components can cause severe or even fatal injury, depending on circumstances, as a result of an electric shock.



- ▶ Never assume that a circuit is dead.



- ▶ Always check circuits as a safety precaution! Components being worked on may only be live if this is absolutely necessary and stipulated.
- ▶ Accident prevention regulations (e.g. VBG4 and VDE 105) must be observed during all work.
- ▶ Only use suitable, intact tools and measuring equipment.

# 3 EC declaration of conformity



## Original EG-Konformitätserklärung

(gemäß der Richtlinie 2006/42/EG, Anhang II, IA)

## Original EC-Declaration of Conformity

(according to Directive 2006/42 / EC, Annex II, IA)

DINA Elektronik GmbH  
Esslinger Str. 84  
72649 Wolfschlugen  
Deutschland

Wir erklären, dass folgendes Produkt allen einschlägigen Bestimmungen der Richtlinie 2006/42/EG entspricht.  
We declare, that the following product fulfils all the relevant provisions of Directive 2006/42 / EC.

Produkt/Product	Funktion/Function
DNSR-2R2 Sicherheitsschaltgerät/safety switching device ID-No. 33SR15, 33SR16, 33SR17, 33SR18, 33SR20	Zeitrelais/time relay

Weitere EU-Richtlinien/Further EC- directives
2014/30/EU EMV-Richtlinie/EMC-Directive 2011/65/EU RoHS Richtlinie/RoHS-Directive

Benannte Stelle/Notified Body	EG Baumusterprüfbescheinigung/EC Type-Examination certificate
DGUV Test Prüf- und Zertifizierungsstelle, Elektrotechnik, Fachbereich: Energie, Textil, Elektro, Medienerzeugnisse Gustav-Heinemann-Ufer 130 D-50968 Köln Kenn-Nr.: Q340	Reg.-Nr./No.: ET 21047

Bevollmächtigter für die Zusammenstellung der technischen Unterlagen/ Authorized representative for the compilation of the technical documents
DINA Elektronik GmbH Esslinger Str. 84 72649 Wolfschlugen Deutschland



Stefan Najib  
Geschäftsführer/CEO

Wolfschlugen, 01.10.2021

# 4 Product description

The **DNSR-2R2** is a switching device for enabling and time delayed enabling of control circuits.

The switching device has two separate starting circuits.

Secure digital inputs and contact outputs are available for this.

The operational readiness and switching status of the contact outputs are displayed using LEDs. The time delay relays are available in different versions with different time delays.



**NOTE**

Potential overvoltages and overcurrents are monitored.

## 4.1 Pin assignment 33SR15 to 33SR18

The pin assignment shown also relates to switching devices 33SR16, 33SR17 and 33SR18.

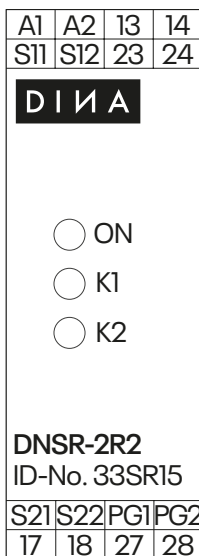

- A1** Operating voltage +24 V DC
- A2** Operating voltage 0 V
- S11** Output control voltage 15 V
- S21** Output control voltage 12 V
- S12** Input starting circuit 1
- S22** Input starting circuit 2
- PG1** Control input for starting contact 13/14
- PG2** Control input for starting contact 23/24
- 13/14** Starting contact (1 NO contact), controllable via PG1
- 23/24** Starting contact (1 NO contact), controllable via PG2
- 17/18** Enabling contact (2 NO contacts), off delay (t1)
- 27/28** Enabling contact2 (2 NO contacts), off delay (t2)
- LED ON** PWR on/off
- LED K1** Relay 17/18 status display
- LED K2** Relay 27/28 status display

## 4.2 Functional specification for 33SR15 to 33SR18

The DNSR-2R 33SR15 to 33SR18 switching devices have two separate starting circuits, each with an off delay contact to release the control circuits.

- The inputs are controlled via the internal 15 V voltage at S11 and 12 V voltage at S21.
- The start buttons must be connected between S11 and S12 (starting circuit 1) and between S21 and S22 (starting circuit 2).
- An external control can be built into the starting circuits via the PG1 and PG2 control inputs and the 13/14 or 23/24 relay contacts.
- The delay times of these devices vary.

<p>▶ Close starting circuit 1 (S11-S12)</p> <p>◀ Enabling contact 17/18 closes without delay.</p>	
<p>▶ Open starting circuit 1 (S11-S12)</p> <p>◀ Enabling contact 17/18 opens with a delay.</p>	
<p>▶ Close starting circuit 2 (S21-S22)</p> <p>◀ Enabling contact 27/28 closes without delay.</p>	
<p>▶ Open starting circuit 2 (S21-S22)</p> <p>◀ Enabling contact 27/28 opens with a delay.</p>	

Delay times	33SR15	33SR16	33SR17	33SR18
t1 (off delay) for 17/18	1.5 s	1.5 s	12 s	12 s
t2 (off delay) for 27/28	45 s	100 s	5 s	5 s

**NOTE**

The delay time can be retriggered.

### 4.2.1 Application example for control input PG1

<p>▶ Connect PG1 to 24 V</p> <p>◀ Starting contact 13/14 closes without delay.</p> <p>▶ Close starting circuit 1 (S11, S12, 13/14)</p> <p>◀ Enabling contact 17/18 closes without delay.</p>	
<p>Enabling contact 17/18 opens with a delay when the starting circuit is opened or the control input deactivated.</p>	

### 4.3 Pin assignment 33SR20

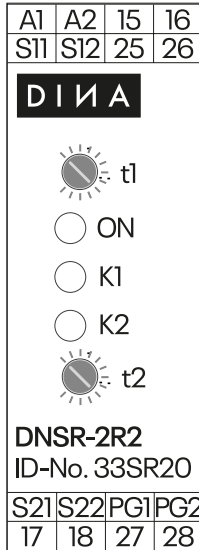

A1	A2	15	16	A1	Operating voltage +24 V DC
S11	S12	25	26	A2	Operating voltage 0 V
				S11	Output control voltage 15 V
				S21	Output control voltage 12 V
				S12	Input starting circuit 1
				S22	Input starting circuit 2
				PG1, PG2	PG1 and PG2 bridged: Enable time setting for t1/t2
				15/16	Diagnostic contact (1 NO contact), on delay (t1)
				25/26	Diagnostic contact (1 NO contact), off delay (t2)
				17/18	Enabling contact (2 NO contacts), off delay (t1)
				27/28	Enabling contact2 (2 NO contacts), off delay (t2)
				LED ON	PWR on/off
LED K1	Relay 17/18 status display				
LED K2	Relay 27/28 status display				

**NOTE**



Diagnostic contacts 15/16 and 25/26 close approximately three seconds after the operating voltage is applied. If the starting circuits are already closed, this is detected and the diagnostic contacts are reopened.

### 4.4 Functional specification for 33SR20

The DNSR-2R 33SR20 switching device has two separate starting circuits with enabling and time-delayed enabling contacts to enable control circuits.

- The inputs are controlled via the internal 15 V voltage at S11 and 12 V voltage at S21.
- The start buttons must be connected between S11 and S12 (starting circuit 1) and between S21 and S22 (starting circuit 2).
- Diagnostic contacts 15/16 and 25/26 close approximately three seconds after the operating voltage is applied.
- The delay times can be set using the front potentiometer.



<ul style="list-style-type: none"> <li>▶ <b>Close starting circuit 1 (S11-S12)</b></li> <li>◀ Enabling contact 17/18 closes without delay.</li> <li>◀ Diagnostic contact 15/16 opens without delay.</li> </ul>	
<ul style="list-style-type: none"> <li>▶ <b>Open starting circuit 1 (S11-S12)</b></li> <li>◀ Enabling contact 17/18 opens with a delay.</li> <li>◀ Diagnostic contact 15/16 closes with a delay.</li> </ul>	
<ul style="list-style-type: none"> <li>▶ <b>Close starting circuit 2 (S21-S22)</b></li> <li>◀ Enabling contact 27/28 closes with a delay.</li> <li>◀ Diagnostic contact 25/26 opens with a delay.</li> </ul>	
<ul style="list-style-type: none"> <li>▶ <b>Open starting circuit 2 (S21-S22)</b></li> <li>◀ Enabling contact 27/28 opens without delay.</li> <li>◀ Diagnostic contact 25/26 closes without delay.</li> </ul>	

**NOTE**

The delay time **cannot** be retrIGGERED.

## 4.5 Setting the delay times

Delay times t1 and t2 can be set using the front potentiometer. The following times can be set:

Delay times	
Off delay time t1	0.5s–3s
On delay time t2	30s–100s

- ▶ Inputs S12 and S22 must not be connected.
- ▶ Bridge terminals PG1 and PG2.
- ▶ Set the times on the potentiometers.
- ▶ Remove the bridge from PG1 and PG2.
- ◀ The settings are permanently saved in the device.

**CAUTION**



Validate the time delays after entering each setting!

# 5 Diagnostics and switching status displays









The module has an LED display indicating

- Operational readiness
- Enabling contact status

## 5.1 LED indicators

Key		
		LED on
		LED off
		LED flashing – Contact our support team at <a href="mailto:support@dina.de">support@dina.de</a>

SAFEONE DNSR-2R	State	
<b>LED</b>		
ON		Power off
		Power on
K1		Enabling circuit 17/18 open
		Enabling circuit 17/18 closed
		1 per second: Delay time t1 counting down 2 per second: Fault
K2		Enabling circuit 27/28 open
		Enabling circuit 27/28 closed
		1 per second: Delay time t2 counting down 2 per second: Fault

## 6 Order information

Description	Product	ID no.
DNSR-2R2 Time Delay Relay	SAFEONE DNSR-2R2	33SR15
		33SR16
		33SR17
		33SR18
		33SR20

## 7 Technical data

### 7.1 Supply

Operating voltage $U_b$	24 V DC ( $\pm 10\%$ )
Current consumption at 24 V	70 mA in rest position 90 mA in working position
Power consumption on A1/A2	1.7 W (rest position), 2.2 W (working position)

### 7.2 Digital inputs

Inputs	S12	S22
Input voltage range	15V DC $\pm 0.5V$	12V DC $\pm 0.5V$

### 7.3 Voltage outputs

Outputs	S11	S21
Voltage	15V DC $\pm 0.5V$	12V DC $\pm 0.5V$

## 7.4 Contact outputs

Outputs	17/18, 27/28	15/16, 25/26	13/14, 23/24
Contact material	Ag alloy		
Output guidance			
Minimum switching current see Contact service life section	3 mA	3 mA	3 mA
Maximum switching current * construction-related limitation	6 A* 1 A	0.5 A	0.5 A
Switching capacity in accordance with IEC 60947-5-1	For 17/18 and 27/28 only DC13: 1.5 A/30 V AC15: 1.5 A/250 V		
Mechanical service life	5 x 10 <sup>7</sup> switching cycles		
Contact fuse	3A gL/gG		
Typical response/release time	10 ms/10 ms		

## 7.5 General data

Type of protection (housing and terminals)	IP 20		
Type of protection (place of installation)	Min. IP 54		
Clearance and creepage distances between circuits	in accordance with DIN EN 50178		
Rated insulation voltage	17/18, 27/28 250V AC	15/16, 25/26 30V AC	13/14, 23/24
Rated surge voltage/insulation	4 kV		
Degree of contamination	2		
Overvoltage category	III		
Housing material	Polyamide (PA), not reinforced		

## 7.6 Connection data

Terminals	Spring force terminals, pluggable
Conductor cross section	0.25–1.5 mm <sup>2</sup>
AWG conductor cross section	AWG 24–16
Conductor type	Flexible with end sleeves
Stripping length	8 mm

## 7.7 Environmental conditions

Operating temperature	-10 °C to +60 °C
Storage temperature	-40 °C to +80 °C
Altitude of place of use	< 2000 m above sea level
Shock resistance	15g, all 3 axes

## 7.8 Dimensions

W x H x D	22.5 x 114 x 111 mm (0.886 x 4.488 x 4.370 in)
Size of DIN rail	35.0 mm (1.378 in)
Weight	150 g

## 7.9 Safety technical data

Stop category in accordance with IEC 60204	1
--	---

## 7.10 Safety-related parameters in accordance with DIN EN ISO 13849-1:2016-06

Performance Level	d
MTTFd [a]	98
PFHd	1.14E-07
Service life	20 years

## 7.11 Contact life

Electrical service life of the output contacts in accordance with DIN EN 60947-5-1/Annex C.3

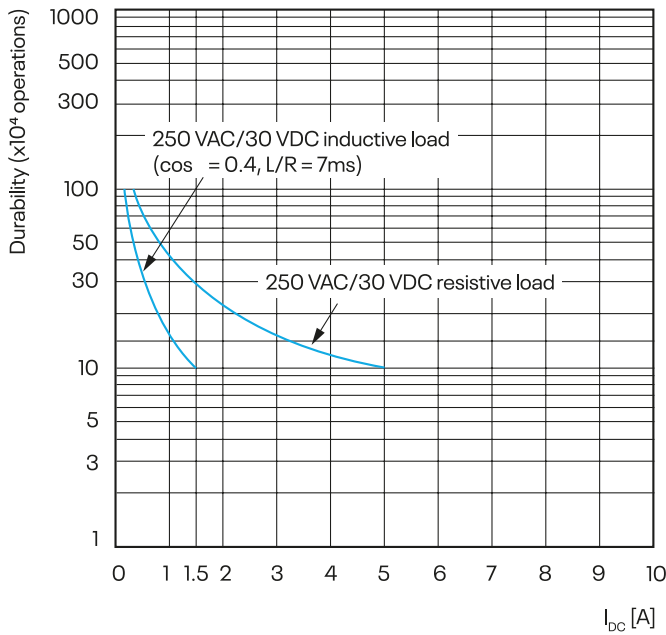

# 8 Installation and removal

## 8.1 Installing a module

### 8.1.1 Overview

- Ⓐ 70–75 mm (2.756–2.953 in)
- ❶ Top hat rail
- ❷ Locking slider
- ❸ Cable duct

#### Procedure

- ▶ Hook the module onto the top hat rail and press it downward.
- ◀ The locking slider ❶ engages under the top hat rail.

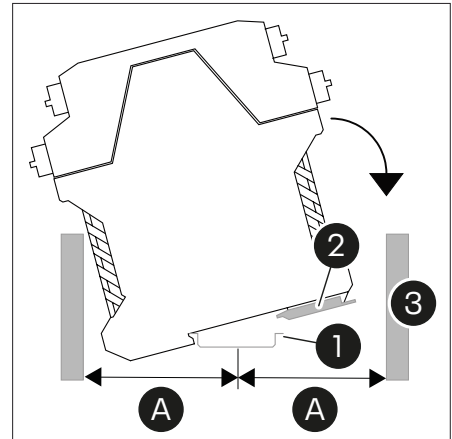

## 8.2 Removing a module

#### Procedure

- ▶ Use a screwdriver ❶ to move the locking slider away from the module.
- ▶ Move the module upward and remove it from the rail.

